

AURA®

gn Edge

The Design

For over 35 years, we've been designing and manufacturing architectural seals that have come to define the benchmark in performance within our industry.

But the time had come for a new challenge — to reimagine what's possible. In essence, we asked ourselves a simple question:

What next?

Contents

04 – 05	Introducing AURA
06 – 07	AURA is good design
08 – 09	Signature design features
10 – 11	Part of a bigger story
12 – 13	Lorient Group
14 – 15	At a glance
16 – 17	Drop seals
18 – 23	Perimeter seals
24 – 31	Threshold plates and ramps
32 – 34	Door bottom seals
35	Additional information and support
36 – 37	Professional and technical information

Introducing AURA —
the functional performance
you've come to expect, but
with a new design sensibility.

AURA is born of the knowledge
that good design is aesthetic as
well as functional. Every aspect
and detail has been carefully
considered as part of an overall
language — one that integrates
seamlessly into your own.





AURA is good design

Dieter Rams, perhaps the most celebrated of all industrial designers, expressed 10 principles that allowed him to answer the question “Is my design good design?”

1. **Good design is innovative**
AURA looks at products that have remained largely unchanged for decades, and asks how they could be improved.
2. **Good design makes a product useful**
AURA contributes towards making better buildings for people to live and work in.
3. **Good design is aesthetic**
AURA embraces signature design features.
4. **Good design makes a product understandable**
AURA benefits from comprehensive product support from specification through to installation and beyond.
5. **Good design is unobtrusive**
AURA integrates beautifully into designed spaces.
6. **Good design is honest**
AURA delivers on performance, supported by real data.
7. **Good design is long-lasting**
AURA is rigorously tested for strength and endurance.
8. **Good design is thorough down to the last detail**
We’ve left no stone unturned in our efforts to reimagine what AURA can deliver.
9. **Good design is environmentally friendly**
AURA reinforces our commitment to sustainability.
10. **Good design is as little design as possible**
Effortless simplicity with timeless appeal.

Signature design features

Because every detail of the AURA design is considered, our products integrate more successfully into beautifully designed doorsets and floors. All AURA products benefit from one or more of the following features:

AURA curve

A distinctive curved profile is present in many AURA products, helping to unify the range, and creating a more sophisticated visual aesthetic, that also spreads and diffuses sound.

Adjustable gaskets

On AURA's innovative new flexible gasket design, the 'blades' can face inwards or outwards, giving the ability to deal with different threshold gaps on site, and ensuring a perfect fit for optimal performance.

Reversible tread

Hardwearing tread inserts deliver greater grip under foot, and the unique reversible design provides either a smooth or ridged surface, depending on practical and aesthetic preferences.

Concealed fixings

AURA fixings are hidden from view, enhancing the overall finish and preserving the clean lines and curves, while also improving security and safety.

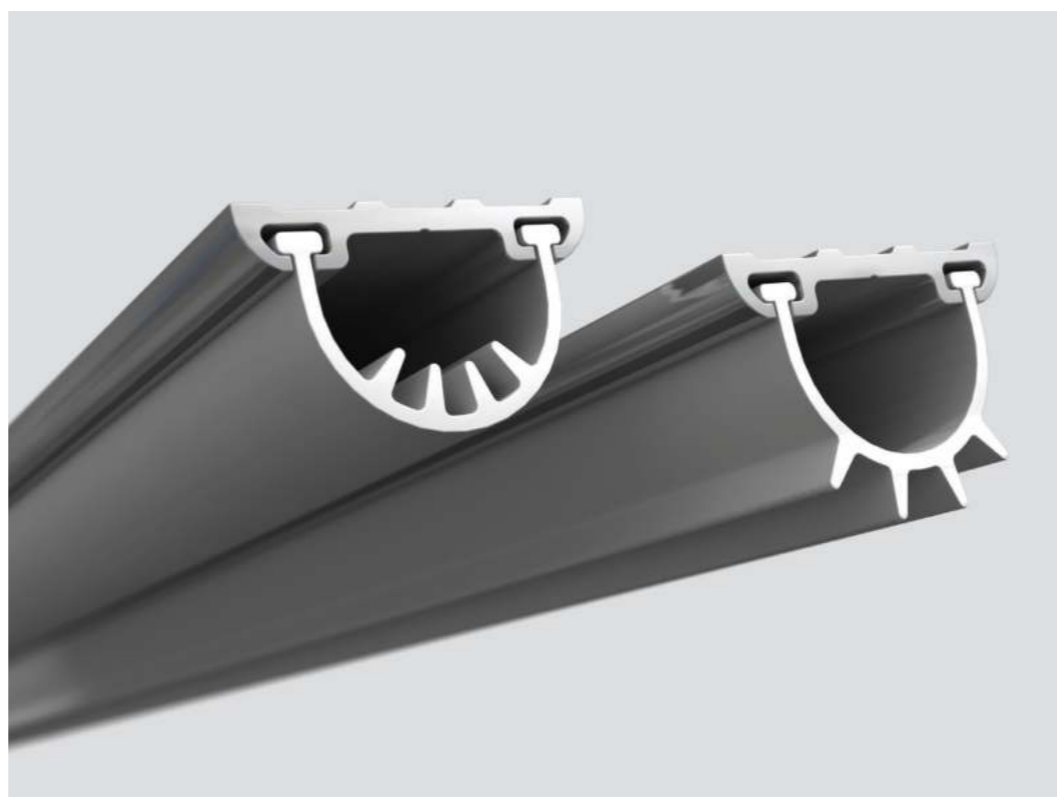
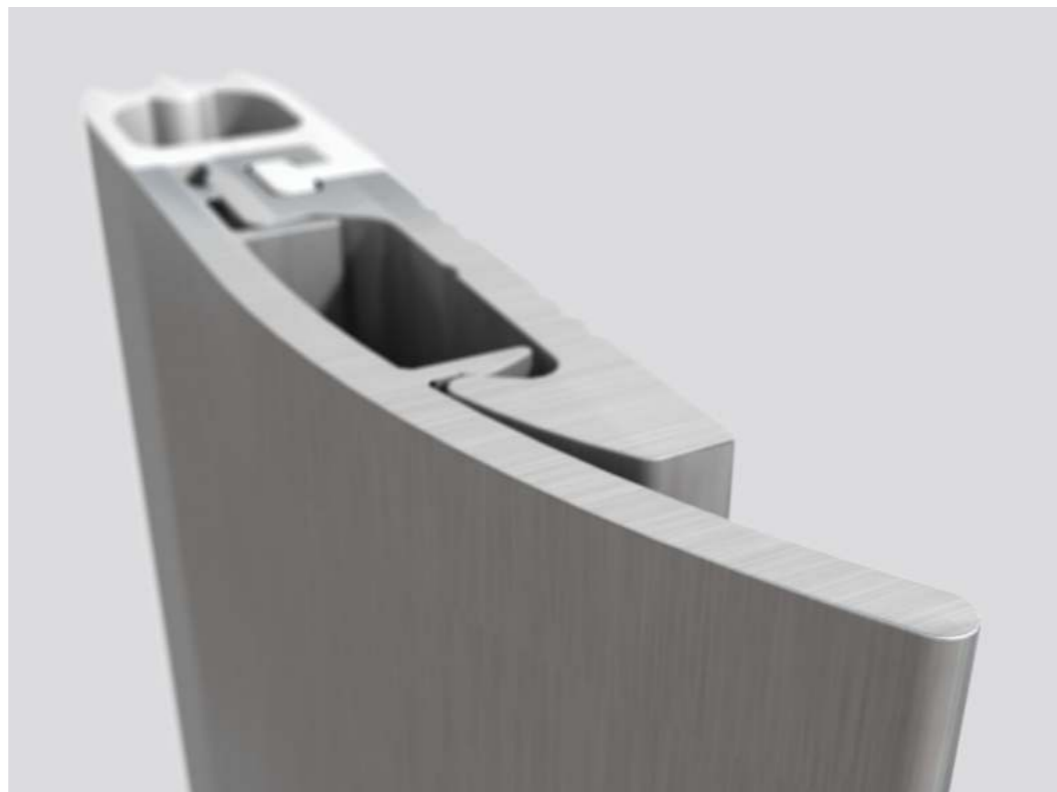



Part of a bigger story. Yours.

A successful design language joins together every aspect of a building's form and function. Opportunities to reinforce an overall aesthetic, no matter how small, are valuable.

Whatever your project demands, AURA responds. Bespoke colours as part of a wider palette. Specialist finishes that blend seamlessly into their surroundings. Luminescence that enhances safety. Illumination that creates a dramatic effect.

Talk to us about your ideas, and we'll work with you to make them a reality.



Lorient acoustic testing facility

Lorient Group

A leader in high performance door sealing systems for over 40 years, with operations around the world, and a longstanding commitment to innovation and quality.

Performs, beautifully

Throughout our history, we have been responsible for countless innovations relating to engineering precision and technical performance. AURA builds on that reputation.

Many seals are tested over a million operating cycles. This kind of durability ensures that products continue to perform at the highest level for as long as possible, reducing both maintenance and waste.

Testing & technical services

AURA made the journey from concept to realisation thanks to our new purpose-built Testing and Technical Services Centre. Specialist facilities include:

- Acoustic transmission suite
- Indicative fire test furnace
- Multiple cycling rigs
- Air and smoke leakage testing equipment
- Environmental chambers
- Analytical laboratory.

Sustainable by design

In 2008 we became the first business in our sector to achieve ISO 14001, the international standard for environmental management. This was reconfirmed in 2017, with a special commendation for our continued progress.

Through our environmental policy we've made a commitment to exceed legal requirements where we can. In pursuit of this, we reduce our waste and manage it well, are vigilant in avoiding the risk of pollution, and use our resources efficiently.

Recent practical initiatives include:

- Creating reusable stillages to despatch products to key customers, reducing packaging
- Installing low wattage lamps and motion sensors, to reduce energy consumption
- Recycling our waste PVC, to reduce the amount being sent to landfill.

At a glance

DROP SEALS

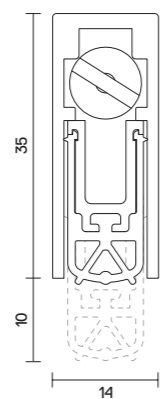

AAS8501 ↑

THRESHOLD PLATES AND RAMPS



AAS4502 ↑



AAS4503 ↑

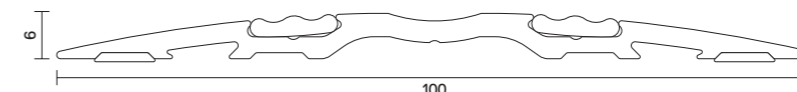

AAS4505 ↑

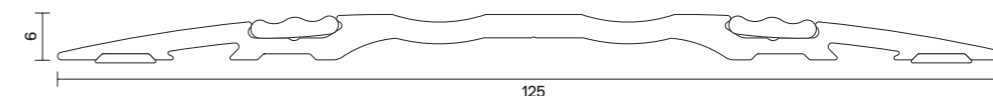

AAS4506 ↑

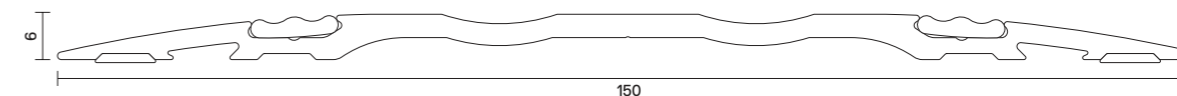

AAS4507 ↑

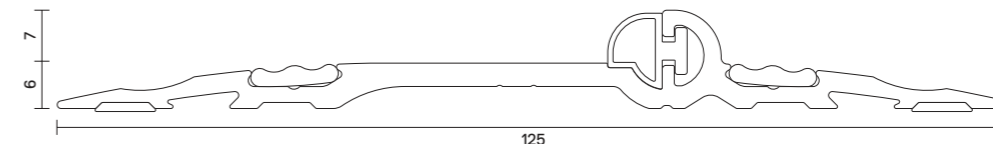

AAS4508 ↑

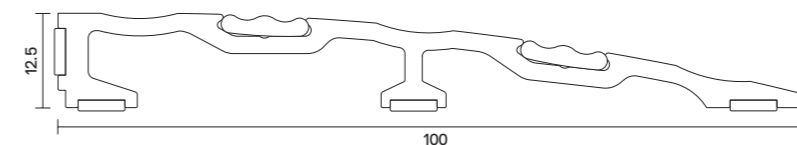

AAS4551 ↑

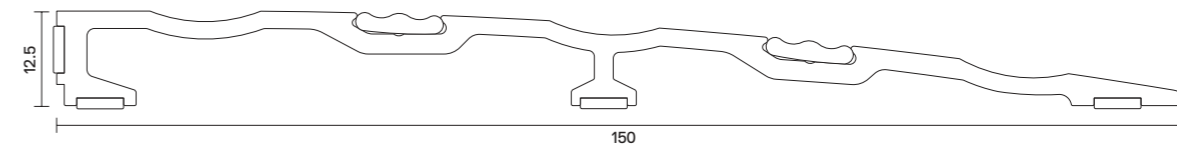



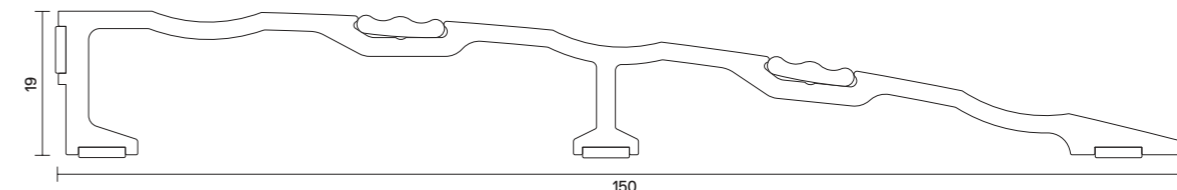



AAS4552 ↑



AAS4553 ↑

ICON KEY

-  Acoustic protection
-  Smoke protection
-  Weather protection
-  Dust protection
-  Draught protection
-  Light protection
-  Wheelchair friendly

PERIMETER SEALS

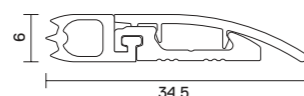

AAS7501 ↑

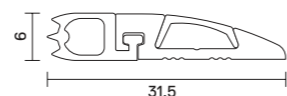

AAS7502 ↑

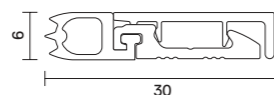

AAS7503 ↑

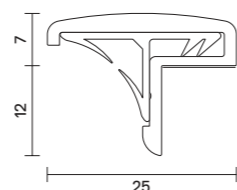

AAS7506 ↑

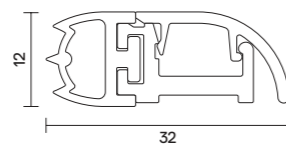

AAS7504 ↑

DOOR BOTTOM SEALS

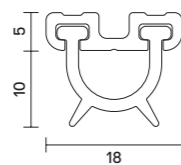

AAS3501 ↑

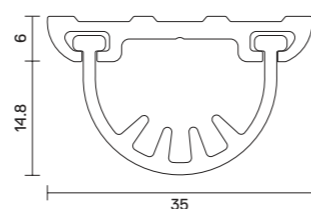

AAS3503 ↑

MEASUREMENTS

Please note that all product illustrations are in millimetres and at a scale of 100% unless otherwise stated.

Drop seals

A high performance, intelligent drop seal that automatically lifts when the door is opened by a few millimetres, and drops when the door is closed.

Research has shown that an unsealed threshold allows both cold smoke and sound to transfer to an adjacent compartment, while also enabling unwanted drafts. It is particularly important for smoke protection where the gap is in excess of 3mm (the maximum allowable for a fire/smoke door).

We recommend sealing all four sides of the door for continuous protection against sound, smoke and energy leakage. Combine an AURA drop seal, threshold plate and perimeter seal for the ultimate sealing system.



8501

AURA®

DROP SEAL

A highly effective, self-levelling drop seal with a unique wrap-around gasket for optimum acoustic and smoke containment. Coloured bands on the brass button help with fine adjustment for varying door gaps.

MEDIUM DUTY



certifire
CF5179

AAS8501 ↓



TECHNICAL

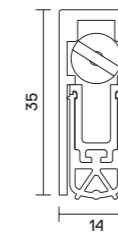

AAS8501 (IN) ↑
(scale: 70%)

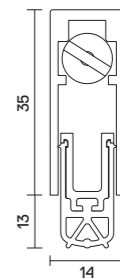

AAS8501 (BLUE SETTING) ↑
(scale: 70%)

Location

Single swing doors.
For use on both right and left handed doors

Min / Max gap size
1mm / 13mm

Seal Material
Silicone

Standard Lengths

- 335mm, 435mm, 535mm, 635mm, 735mm, 835mm, 935mm, 1035mm, 1135mm
- Each length cuts back to next size down (335mm cuts back to 255mm). Longer lengths available

PERFORMANCE

Acoustic

BS EN ISO 10140-2: 2010

Weighted Sound Reduction Index

31 dB
(AAS7501 & AAS8501 on a standard architectural door)

Fixing

Secured via stainless steel radiused end plates (21mm x 57mm). Two coloured bands on the adjuster indicate a nominal 10mm gap (blue) and the maximum 13mm gap (red), but any gap size from 1mm – 13mm can be accommodated

Finishes

- Silver anodised aluminium with Silver end plates and Silver silicone gasket
- Silver anodised aluminium with Bronze end plates and Black silicone gasket

Smoke Leakage

BS EN 1634-3: 2004
BS 476: Pt.31.1: 1983

Durability

1 million cycles on full-size door assemblies

Perimeter seals

A range of stylish, slimline perimeter seals for installation around the head, jambs and meeting stiles* of doors.

Gaps between the door and frame or on meeting stiles of double doors allow both cold smoke and sound to transfer to an adjacent compartment; as well as energy through the escape of hot or cold air. It is essential to seal the perimeter of the door for effective acoustic, smoke and energy containment.

The perimeter seals feature AURA's signature curve which merges almost seamlessly with the doorframe.

The decorative cover plates and strips neatly conceal fixings and are available in a range of different colours.

The aluminium carriers are pre-drilled for adjustable retrofit installation.

We recommend sealing all four sides of the door for continuous protection against sound, smoke and energy leakage. Combine an AURA perimeter seal, with a drop seal and threshold plate for the ultimate sealing system.

* Only AAS7506

7501

AURA®

PERIMETER SEAL

Designed with a seamless curve for enhanced aesthetics, with proven performance for acoustic and smoke containment when installed around the head and jambs of doors. The decorative snap-on cover plate completely conceals fixings and is available in a range of finishes.

MEDIUM DUTY



certifire

CF5179

TECHNICAL

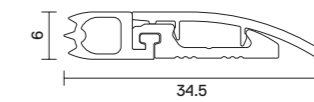

AAS7501 ↑

Location

Head and jambs of single swing doors

Seal Material

Silicone

Standard Lengths

- 1m and 2.1m
- Doorset packs 1x1m + 2x2.1m
- Other lengths available for special order

Fixing

- Fixing holes pre-drilled and slotted for positional accuracy
- Wood screws supplied – please request self-tappers

Finishes

- Silver anodised aluminium with Silver silicone gasket
- Bronze anodised aluminium with Black silicone gasket
- Decorative finishes available. Please enquire

PERFORMANCE

Acoustic

BS EN ISO 10140-2: 2010

Weighted Sound Reduction Index

31 dB

(AAS7501 & AAS8501 on a standard architectural door)

Smoke Leakage

BS EN 1634-3: 2004
BS 476: Pt.31.1: 1983

Durability

1 million cycles on full-size door assemblies

AAS7501 ↓



7502

PERIMETER SEAL

A slimline perimeter seal featuring sweeping curves. Proven performance for acoustic and smoke containment when installed around the head and jambs of doors. The decorative cover strip completely conceals fixings and is available in a range of finishes.

MEDIUM DUTY



certifire
CF5179

AAS7502 ↓

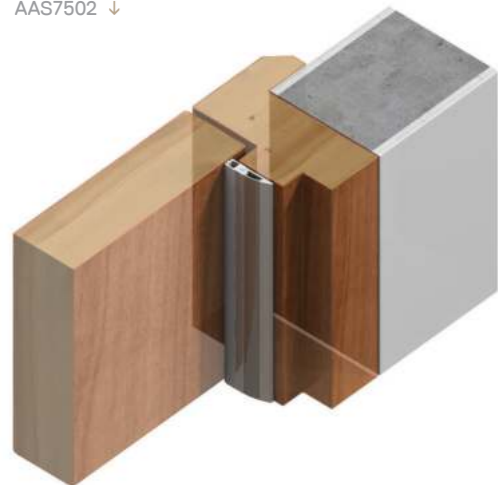

TECHNICAL

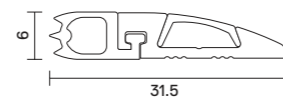

AAS7502 ↑

Location

Head and jambs of single swing doors

Seal Material

Silicone

Standard Lengths

- 1m and 2.1m
- Doorset packs 1x1m + 2x2.1m
- Other lengths available for special order

Fixing

- Fixing holes pre-drilled and slotted for positional accuracy
- Wood screws supplied – please request self-tappers

Finishes

- Silver anodised aluminium with Silver silicone gasket
- Bronze anodised aluminium with Black silicone gasket
- Decorative finishes available. Please enquire

PERFORMANCE

Acoustic

BS EN ISO 10140-2: 2010

Weighted Sound Reduction Index

31 dB

(AAS7502 & AAS8501 on a standard architectural door)

Smoke Leakage

BS EN 1634-3: 2004

BS 476: Pt.31.1: 1983

7503

PERIMETER SEAL

A stylish perimeter seal with square cover plate ideal for butt-jointing or mitring. Proven performance for acoustic and smoke containment. The decorative cover plate completely conceals fixings and is available in a range of finishes.

MEDIUM DUTY



certifire
CF5179

AAS7503 ↓



TECHNICAL

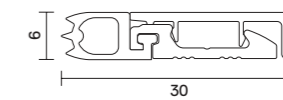

AAS7503 ↑

Location

Head and jambs of single swing doors

Seal Material

Silicone

Standard Lengths

- 1m and 2.1m
- Doorset packs 1x1m + 2x2.1m
- Other lengths available for special order

Fixing

- Fixing holes pre-drilled and slotted for positional accuracy
- Wood screws supplied – please request self-tappers

Finishes

- Silver anodised aluminium with Silver silicone gasket
- Bronze anodised aluminium with Black silicone gasket
- Decorative finishes available. Please enquire

PERFORMANCE

Acoustic

BS EN ISO 10140-2: 2010

Weighted Sound Reduction Index

31 dB

(AAS7503 & AAS8501 on a standard architectural door)

Smoke Leakage

BS EN 1634-3: 2004

BS 476: Pt.31.1: 1983

Durability

1 million cycles on full-size door assemblies

7504

PERIMETER SEAL

A compact perimeter seal ideal for acoustic and smoke containment. It can be used to replace the doorstop on steel or timber framed doors. We recommend the use of a door closer to aid closing control and to avoid excessive impact.

MEDIUM DUTY



AAS7504 ↓



TECHNICAL

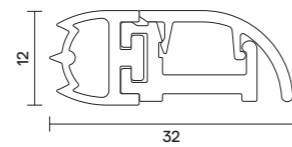

AAS7504 ↑

Location

Head and jambs of single swing doors

Seal Material

Silicone

Standard Lengths

- 1m and 2.1m
- Doorset packs 1x1m + 2x2.1m
- Other lengths available for special order

Fixing

- Fixing holes pre-drilled and slotted for positional accuracy
- Wood screws supplied – please request self-tappers

Finishes

- Silver anodised aluminium with Silver silicone gasket
- Bronze anodised aluminium with Black silicone gasket
- Decorative finishes available. Please enquire

PERFORMANCE

Acoustic

BS EN ISO 10140-2: 2010

Weighted Sound Reduction Index

31 dB

(AAS7504 & AAS8501 on a standard architectural door)

7506

PERIMETER SEAL

A robust seal designed for use on plain or rebated meeting stiles. With proven acoustic performance it is also suitable for smoke, light, and draught containment. The leg can be cut out to make way for locks and latches.

MEDIUM DUTY



certifire

CF5179

AAS7506 ↓



TECHNICAL

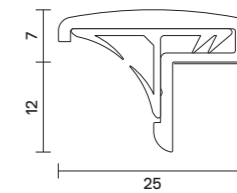

AAS7506 ↑

Location

Meeting stiles of single swing doors. Double doors – where only one door leaf is in use

Seal Material

Co-extruded elastomeric with flexible curved fins

Standard Lengths

- 1m and 2.1m

Fixing

- Fixing holes pre-drilled and countersunk
- Wood screws supplied – please request self-tappers
- Using self-adhesive tape to position aluminium carrier while fixing, push-fit Batwing® seal into place

Note: A door selector should be considered unless one leaf is intended to be fixed

Finishes

- Silver or Bronze anodised aluminium
- Black, White, Dark Brown, Light Brown, Grey, Clear and Cream Batwing® inserts available

PERFORMANCE

Acoustic

BS EN ISO 10140-2: 2010

Weighted Sound Reduction Index

33 dB

(AAS7506 & AAS8501 on a standard architectural door)

Smoke Leakage

BS EN 1634-3: 2004

BS 476: Pt.31.1: 1983

Durability

1 million cycles on full-size door assemblies

Threshold plates and ramps

A collection of beautifully designed, hardwearing anodised aluminium threshold plates and ramps, that affix to the sill beneath the door.

Threshold plates provide a firm and effective sealing surface for both door bottom seals and drop seals to rest against, while also covering the join between different floor materials. Threshold ramps feature a gentle sloping gradient to accommodate differences in floor heights.

AURA threshold plates and ramps are low profile and do not impede wheeled traffic nor do they present any tripping hazard to pedestrian traffic. Acoustic bedding pads reduce vibration and noise, while providing cushioning on uneven surfaces (apart from AAS4502/AAS4503).

We recommend sealing all four sides of the door for continuous protection against sound, smoke and energy leakage. Combine an AURA threshold plate, with a door bottom seal and perimeter seal for the ultimate system.

4502 4503

THRESHOLD PLATES

A seamless aluminium threshold plate. Fixings are concealed with a snap-on cover plate for premium aesthetics. Combine the 4502/4503 with a drop seal or door bottom seal to prevent rain, draught and smoke penetration.

MEDIUM DUTY



AAS4502 ↓



TECHNICAL

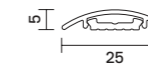

AAS4502 ↑ (scale: 56%)

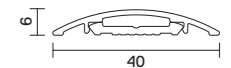

AAS4503 ↑ (scale: 56%)

Location

Single and double swing doors

Seal Material

Aluminium cover
Heavy duty polymer fixing plate

Standard Lengths

- 1m and 2.1m
- Other lengths available for special order

Fixing

- Fixing screws supplied

Finishes

- Silver or bronze anodised aluminium
- Decorative finishes available on request

AAS4503 ↓



4505

THRESHOLD PLATE

The curved profile on this plate features unique reversible tread strips, offering either a smooth or ridged finish. A unique central 'scoop' feature further enhances grip for foot or wheeled traffic.

MEDIUM DUTY



AAS4505 ↓

TECHNICAL

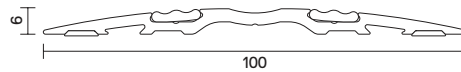

AAS4505 ↑ (scale: 56%)

Location

Single and double swing doors

Seal Material

Aluminium with two flexible tread strips

Standard Lengths

- 1m and 2.1m
- Other lengths available for special order

Fixing

- Pre-drilled and countersunk
- Fixing screws supplied
- Tread strips supplied and push-fit into plate to conceal fixings

Finishes

- Silver anodised aluminium with Silver tread strips
- Bronze anodised aluminium with Black tread strips
- Decorative finishes for threshold plate and different colour tread strips available on request



4506 4507

THRESHOLD PLATES

The curved profile on the largest plates in the range feature two reversible tread strips (smooth or ridged). Unique 'scoop' feature further enhances grip for foot or wheeled traffic.

MEDIUM DUTY



AAS4506 ↓



TECHNICAL

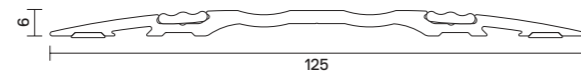

AAS4506 ↑ (scale: 56%)

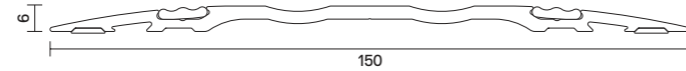

AAS4507 ↑ (scale: 56%)

Location

Single and double swing doors

Seal Material

Aluminium with two flexible tread strips

Standard Lengths

- 1m and 2.1m
- Other lengths available for special order

Fixing

- Pre-drilled and countersunk
- Fixing screws supplied
- Tread strips supplied and push-fit into plate to conceal fixings

Finishes

- Silver anodised aluminium with Silver tread strips
- Bronze anodised aluminium with Black tread strips
- Decorative finishes for threshold plate and different colour tread strips available on request

AAS4507 ↓



4508

THRESHOLD PLATE

A stylish stepped threshold plate ideal for acoustics. Acoustic containment is enhanced by the silicone gasket; and acoustic bedding pads reduce vibration and provide cushioning on uneven surfaces.

MEDIUM DUTY

AAS4508 ↓



TECHNICAL

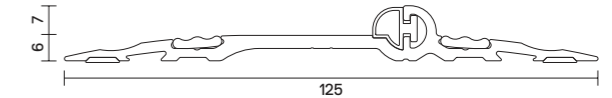

AAS4508 ↑ (scale: 56%)

Location

Single swing doors

Seal Material

Aluminium with two flexible tread strips

Standard Lengths

- 1m and 2.1m
- Other lengths available for special order

Fixing

- Pre-drilled and countersunk
- Fixing screws supplied
- Tread strips supplied and push-fit into plate to conceal fixings

Finishes

- Silver anodised aluminium with Silver tread strips
- Bronze anodised aluminium with Black tread strips
- Decorative finishes for threshold plate and different colour tread strips available on request

PERFORMANCE

Acoustic

BS EN ISO 10140-2: 2010

Weighted Sound Reduction Index

33 dB

(AAS4508 & LAS1212 & LP1504DS on a standard architectural door)

4551 4552

THRESHOLD RAMPS

For use in buildings where wheelchairs and trolleys are used, or to compensate for uneven floors. Reversible tread strips provide greater traction. Unique ‘scoops’ further enhance grip for foot or wheeled traffic.

MEDIUM DUTY



AAS4551 ↓



TECHNICAL

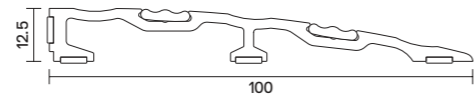

AAS4551 ↑ (scale: 56%)

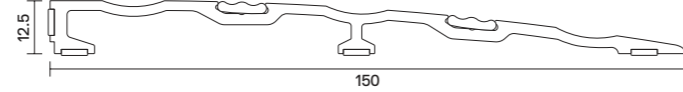

AAS4552 ↑ (scale: 56%)

Location

Single and double swing doors

Seal Material

Aluminium with two flexible tread strips

Standard Lengths

- 1m and 2.1m
- Other lengths available for special order

Fixing

- Pre-drilled and countersunk
- Fixing screws supplied
- Tread strips supplied and push-fit into plate to conceal fixings

Finishes

- Silver anodised aluminium with Silver tread strips
- Bronze anodised aluminium with Black tread strips
- Decorative finishes for threshold plate and different colour tread strips available on request

AAS4552 ↓



4553

THRESHOLD RAMP

For use where wheelchairs and trolleys are used or to compensate for uneven floors. Reversible tread strips offer greater friction underfoot. Unique ‘scoops’ further enhance grip for foot or wheeled traffic.

MEDIUM DUTY



AAS4553 ↓



TECHNICAL

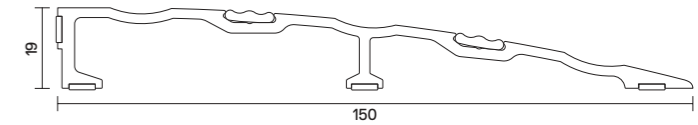

AAS4553 ↑ (scale: 56%)

Location

Single and double swing doors

Seal Material

Aluminium with two flexible tread strips

Standard Lengths

- 1m and 2.1m
- Other lengths available for special order

Fixing

- Pre-drilled and countersunk
- Fixing screws supplied
- Tread strips supplied and push-fit into plate to conceal fixings

Finishes

- Silver anodised aluminium with Silver tread strips
- Bronze anodised aluminium with Black tread strips
- Decorative finishes for threshold plate and different colour tread strips available on request

3501

Door bottom seals

A range of versatile and hardwearing door bottom seals that can be surface mounted or concealed in a rebated groove at the bottom of the door leaf*.

Each door bottom seal in the AURA range can be adjusted to suit varying gap sizes at the threshold. All the gaskets are reversible (smooth or blade projections) to accommodate different gap sizes.

Research has shown that an unsealed threshold presents a high risk area. Gaps at the bottom of a door and the floor allow cold smoke, sound and drafts to transfer to an adjacent compartment.

Door bottom seals are particularly important for smoke protection where the gap is more than 3mm (maximum allowable for a fire/smoke door). This is also essential for effective acoustic containment (an acoustic sealing system is only effective if it incorporates every gap around the perimeter of a door).

* AAS3501 only

DOOR BOTTOM SEAL

The unique slide-in gaskets can be cleverly reversed (blades in/out) for maximum flexibility. Suitable for single and double swing doors, as well as meeting stiles.

MEDIUM DUTY



TECHNICAL

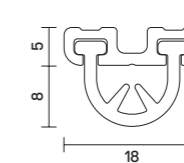

AAS3501 (BLADES IN) ↑

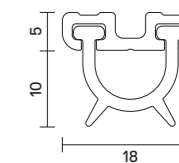

AAS3501 (BLADES OUT) ↑

Location

Rebated or surface mounted at the bottom of single, double swing doors and on one leaf at the meeting stile of double swing doors

Min / Max gap size
8mm / 10mm

Seal Material
Silicone

Standard Lengths

- 1m and 2.1m
- Other lengths available for special order

Fixing

- Fixing holes pre-drilled
- Screws supplied
- When aluminium carrier is fixed in place, gasket slides into carrier (with blades in/out) – concealing fixings

Note: these seals cannot be adjusted once fitted

Finishes

- Silver anodised aluminium with Silver silicone gasket
- Bronze anodised aluminium with Black silicone gasket

AAS3501 + AAS4502 ↓



3503

DOOR BOTTOM SEAL

The unique slide-in gaskets can be cleverly reversed with blade in/out. Suitable for single and double swing doors, as well meeting stiles (one leaf only).

MEDIUM DUTY



AAS3503 + AAS4503 ↓



TECHNICAL

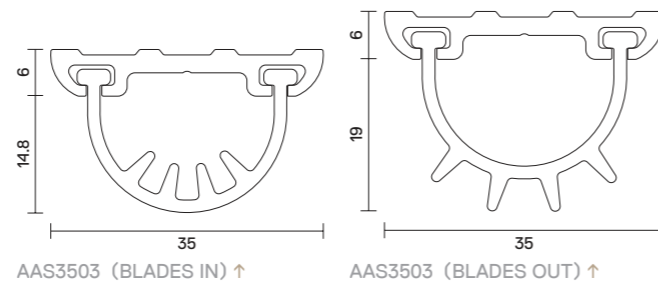

Location

Surface mounted at the bottom of single, double swing doors and meeting stile of double swing doors

Min / Max gap size
20.8mm / 25mm

Seal Material
Silicone

Standard Lengths

- 1m and 2.1m
- Other lengths available for special order

Fixing

- Fixing holes pre-drilled
- Screws supplied
- When aluminium carrier is fixed in place, gasket slides into carrier (with blades in/out) – concealing fixings

Note: these seals cannot be adjusted once fitted

Finishes

- Silver anodised aluminium with Silver silicone gasket
- Bronze anodised aluminium with Black silicone gasket

Additional information

If you have a particular requirement which isn't covered by the applications presented in this brochure, we may be able to supply an existing non-standard item, or even develop a customised solution for you.

All AURA seals are compatible with the materials normally used in doors and door frames. These include wood, steel, PVC, glass and aluminium.

Please Note: Recommendations as to methods, use of materials and construction details are based on the experience and knowledge of Lorient and are given in good faith as a general guide and a service to designers, contractors and manufacturers.

Replacement parts

If you require replacement AURA gaskets, cover strips, tread strips, or any other parts from the range, please do not hesitate to give us a call on +44(0)1626 834252.

Care & maintenance

We have taken great care to deliver the best quality products with reliable performance. Care and maintenance will help to ensure the longevity of the product.

A periodic inspection and cleaning is recommended for all types of AURA seals. The appearance and performance of our products will benefit from an annual wipe with a damp cloth. Seals should be checked for correct adjustment. Worn or damaged seals should be replaced immediately.

Installation

We have designed the AURA range with ease of installation in mind. To ensure that they work to their full potential, it is essential that they are fitted correctly.

Comprehensive fitting guides are included with each consignment; and are also available to download from our website www.lorientuk.com. If you need any further help, please do not hesitate to give us a call on +44(0)1626 834252.

Support

Our technical experts work with architects from the pre-design stage onwards, providing guidance on specific products or projects. We offer specialist advice on all matters relating to acoustic, smoke and fire containment; on meeting the requirements of the Building Regulations, help with installation or assistance with colours and finishes.

For access to a wide range of useful online supporting documentation: fitting guides, CAD drawings, NBS specification text, certification documents, acoustic search tool, product animations plus much more – visit www.lorientuk.com

Or call our Technical Services team on +44(0)1626 834252.

Technical references

Lorient is quality assured under the disciplines of BS EN ISO 9001:2015. This internationally recognised standard for quality management is a guarantee that we conduct our business to the complete satisfaction of our customers with regard to design solutions, manufacturing consistency and management procedures. It generates customer confidence and eliminates the risk of poor performance. Regular audits of our company procedures are undertaken by qualified BSI staff.



Lorient has attained the internationally recognised BS EN ISO 14001:2015 accreditation for environmental management – we are the first seal manufacturer to have achieved this award. It demonstrates our commitment to responsible environmental behaviour, including prevention of pollution, control and reduction of waste, and on-going monitoring and improvement of our environmental performance.



CERTIFIRE is an accredited independent product conformity scheme operated by Exova Warrington Fire Certification Limited.

As part of the CERTIFIRE schedule products are required:

- to add minimal resistance to opening and closing; to meet the requirements of BS 9999 when tested for smoke leakage according to BS 476 Section 31.1: 1983, even after endurance an test of 100,000 opening and closing cycles;
- to maintain consistent seal quality according to the disciplines of a recognised quality assurance scheme, for example BS EN ISO 9001: 2015;
- to prove long term performance under a variety of service conditions;
- to be permanently marked so they can be easily identified.

These measures serve to ensure that only products demonstrating a consistently high quality and proven performance carry the CERTIFIRE marque.

certifire

Continuing Professional Development Seminars

Developing professional skills and keeping knowledge up-to-date with changing regulations is an on-going challenge. We offer three RIBA accredited Continuing Professional Development (CPD) seminars:

- Performance Door Design: The Basics of Sound Reduction
- The Role and Performance of Fire and Smoke-Resisting Door Assemblies
- Understanding the Regulatory Reform (Fire Safety) Order 2005 and its implication for fire doors.

Each seminar provides an opportunity to keep up-to-date with all the latest facts about acoustic, smoke and fire containment, including regulations and standards – as well as exploring practical solutions.

For further information
about Lorient products
please visit our website:

www.lorientgroup.com

UK & Europe

Tel: +44 (0) 1626 834252
Fax: +44 (0) 1626 833166
Email: mktg@lorientuk.com

Hong Kong

Tel: +852 2505 0328
Fax: +852 2505 0332
Email: sales@lorienthk.com

USA

Tel: +1 859 252 7441
Fax: +1 859 381 1241
Email: inquiries@lorientna.com

Dubai

Tel: +9714 883 7206
Fax: +9714 883 7207
Email: sales@lorientgulf.ae

Singapore

Tel: +65 6270 1279
Email: sales@lorient.com.sg

Australia

Tel: +61 (02) 9907 6221
Email: sales@lorient.com.au



Lorient Polyproducts Ltd
Endeavour House
Fairfax Road
Heathfield Ind Estate
Newton Abbot
Devon TQ12 6UD
United Kingdom

ASSA ABLOY

An ASSA ABLOY group brand

Twitter
[@LorientUK](https://twitter.com/LorientUK)

LinkedIn
[/company/lorient](https://www.linkedin.com/company/lorient)

YouTube
[LorientPolyproducts](https://www.youtube.com/LorientPolyproducts)

Instagram
[lorientuk](https://www.instagram.com/lorientuk)